

## AMT U40W1.2

### Tweeter

Samples available: Immediately  
Start of sale: Immediately

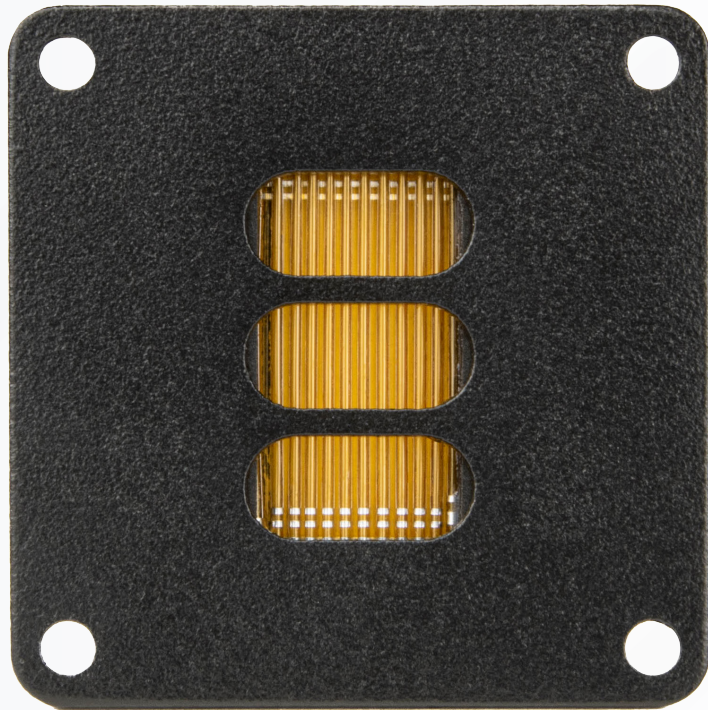

The **AMT U40W1.1** is the smallest model in the **U.Series**. It is suitable for 2-way table top speakers as well as for 3-way floor standing speakers. Thanks to its compact design, the **AMT U40W1.1** can also be effortlessly integrated into Car- HiFi systems. Small as it is, it provides all the quality features of the **AMT U.Series** with **Mundorf diaphragm**: Exceptionally low K3 / K5 distortion data, a truly powerful music performance within the entire application range and, at the same time, the fine micro-dynamics and richness of music details that distinguish all **Mundorf AMT's**.

## Specifications

Nominal Impedance	4 Ω
DC Resistance ( $R_{dc}$ ) ( $Z_{min}$ )	3.7 Ω
Sensitivity (2,83 V / 1m) <sup>1</sup>	92 dB
Resonance Frequency (FS)	3900 Hz
Frequency Response (-6dB)	3.0 kHz - 40 kHz
Frequency Response (-10dB) <sup>1</sup>	2.7 kHz - 43 kHz
Crossover from (filter 12dB/6dB/Oct.)	3.5 kHz / 5.0 kHz
Nominal Frequency Range <sup>3</sup>	3.5 kHz - 40 kHz
Power Handling, long term <sup>1,2</sup>	10 W
Power Handling, short term <sup>1,2</sup>	80 W
Max. Input Voltage, long term <sup>1,2</sup>	6.3 V <sub>rms</sub>
Max. Input Voltage, short term <sup>1,2</sup>	17.9 V <sub>rms</sub>
Effective Piston Area	13.5 cm <sup>2</sup>
Total Weight	0.174 kg
Face Plate	optional

- 1) according to IEC 60268-5  
 2) via High Pass Filter, Butterworth 3500 Hz 12 dB/Okt.  
 3) according to power measurement

## Measurements

SPL Horizontal 0° - 15° - 30° - 45° - 60°

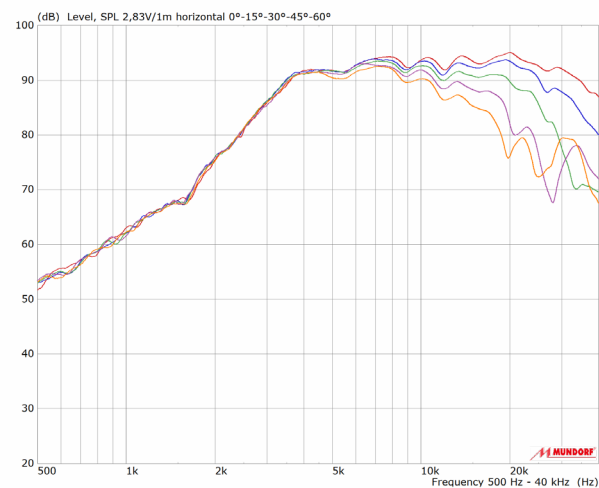

SPL Vertical 0° - 10° - 20° - 30° - 45°

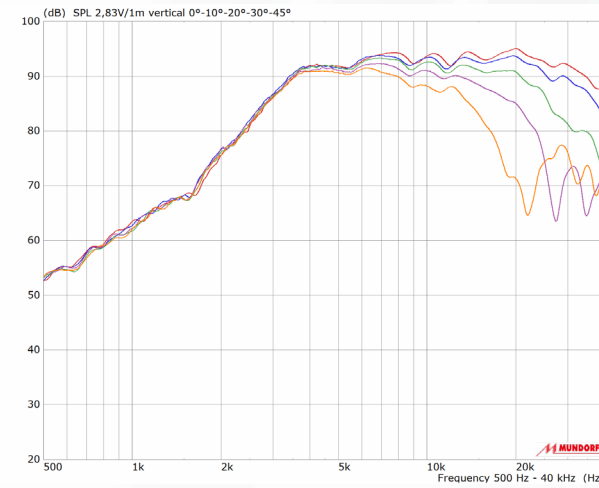

## Measurements

### SPL without / with Faceplate - Impedance

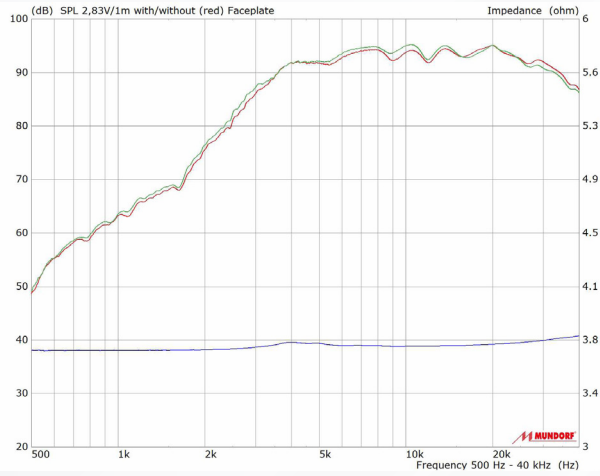

### Harmonic Distortion 2.83 V

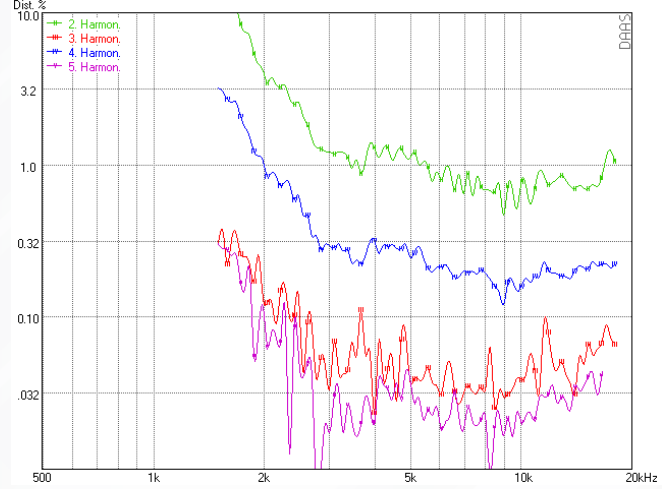

### Waterfall

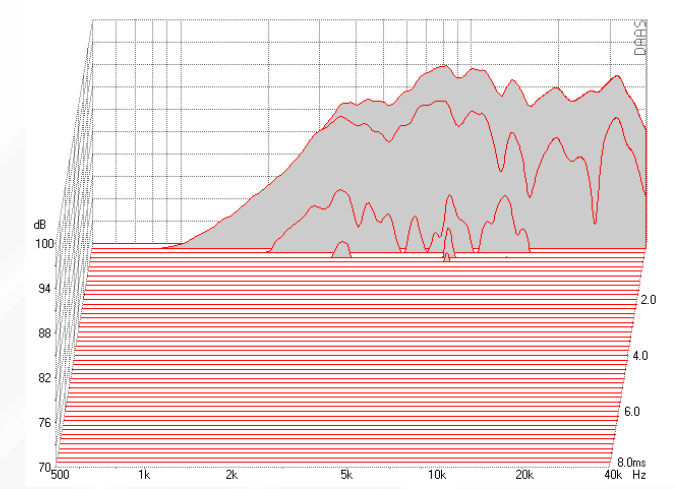

### SPL - Phase

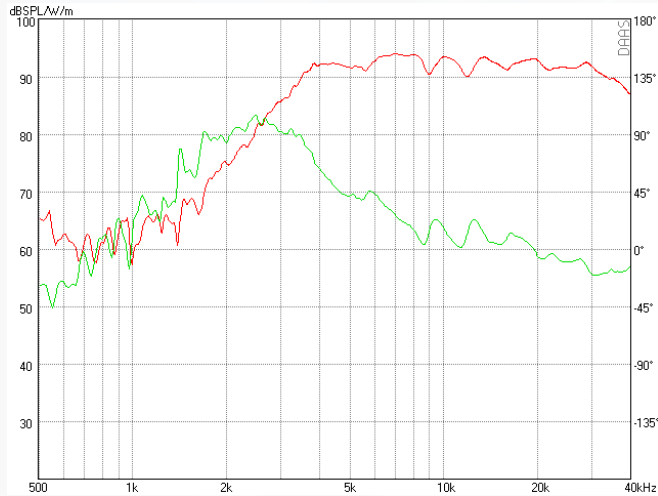

### Impulse Response

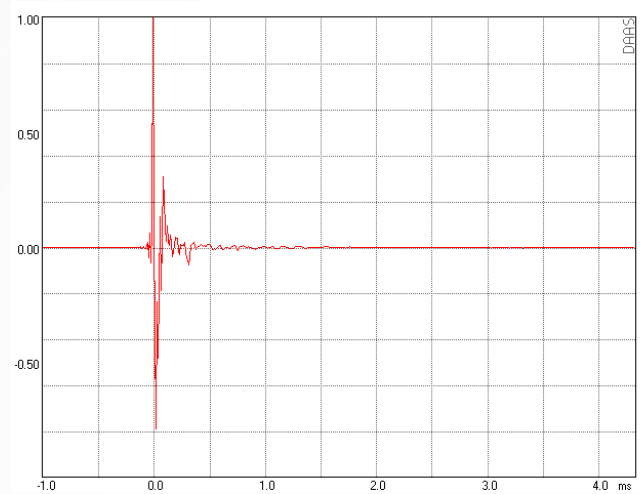

### Step Response

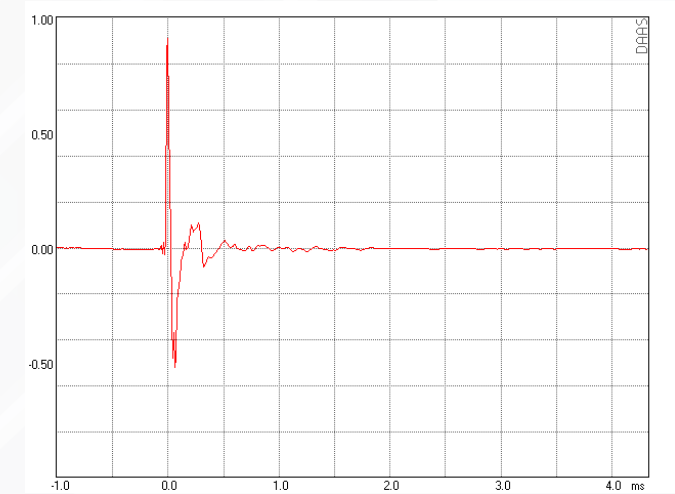

Dimensions

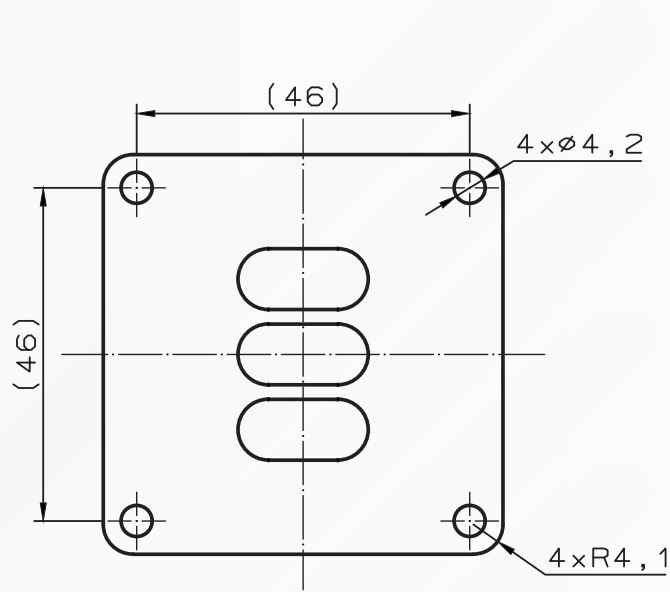

Front view

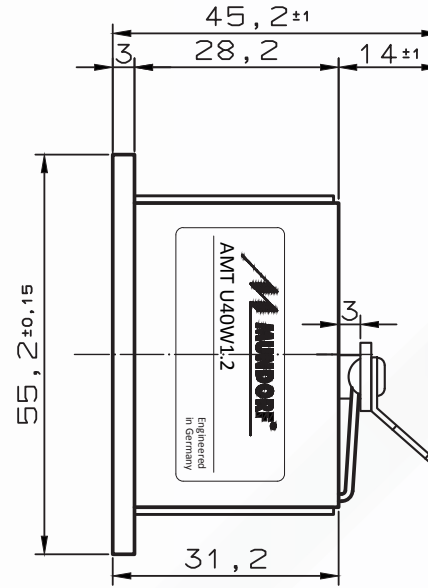

Sideview

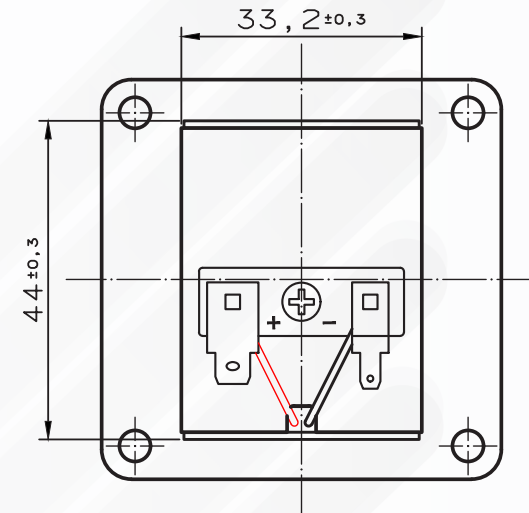

Rear view

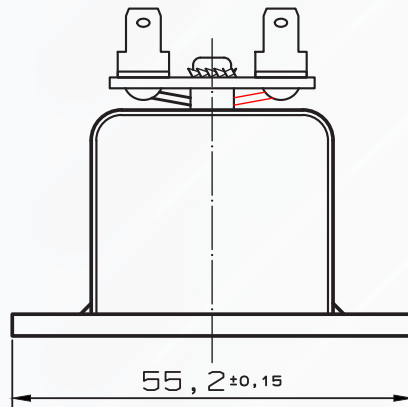

Top view

	Dimensions	Tolerance
Length	55,2 mm	+ 0,15 mm
Width	55,2 mm	+ 0,15 mm
Depth including terminal	45,2 mm	+/- 1 mm

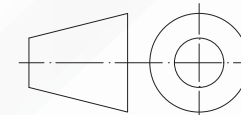

All measurements are in mm.